



**Gas Oven**

**GB6/GB6P**



British Built for Purpose.





# Welcome to Parry

Parry is one of the UK's foremost manufacturers of high-quality Stainless Steel Fabricated Products with a 40-year heritage rooted in British craftsmanship.

At Parry, quality and service are second nature. Striving to exceed our customers' expectations is not just our motto; it's the very heartbeat of our business. Our commitment to our customers is reflected in the **Parry 4E Standard Inspection Body** stating that all our products are:



**Easy to use**



**Easy to maintain**



**Easy to clean**



**Easy to repair**

Our ranges of Stainless Steel Products have been specifically designed with the consumer in mind and are tailored and compliant to your specific industry sector. All our products are 4E Compliant and meet EU & UK regulations, where applicable. The Parry brand stands for quality, reliability and value.

Our British designed products have been created by our expert in-house development team and manufactured to exacting standards using Industry specified grade of European stainless steel and holding relevant EU & UK certification for all product.

ISO9001 certification and continual investment in the training and development of our highly skilled, artisan workforce means that our clients have genuine peace of mind that they are buying hand crafted, quality products supported by five-star customer service. All Parry products meet EU regulations for their respective sector.

We are LEAN manufacturers, minimising waste, maximising productivity. We are proud to run an operation that is committed to minimising our impact on the environment.

Our equipment and furniture are manufactured in our 45,000 sq ft manufacturing facility in Draycott, Derbyshire in England's industrial heartland. Products are made to order if not available in our stocked items which means you can choose from 600 products, offering over 3,500 variants, with short lead times to suit your specific needs. That means you get exactly what you need when you need it.

Our product information can be found here, in our brochure or on our website [www.parry.co.uk](http://www.parry.co.uk).

You have my personal commitment that Parry will exceed your expectations. Should you have any questions please contact your distributor. Alternatively, our customer services team will be happy to help you on **01332 875544**.

**Mark Banton MBA**  
**Managing Director**



# Contents

---

Contents .....	1
Product Overview .....	2
Safety Instructions .....	3
Installation Instructions .....	4-6
Operating Instructions .....	6-7
Cleaning Instructions .....	8
Maintenance Instructions .....	9
Fault Finding .....	10
Replacement Parts.....	11
Natural Gas Conversion Instructions.....	12
LPG Gas Conversion Instructions .....	13
Conversion Procedure.....	14-16
Technical Information .....	17
Service Information .....	18
Exploded View .....	19
Parts List .....	20-21
Warranty Information.....	22
Disposal & Recycling .....	23

Parry Catering Equipment (Midlands) Ltd, Town End Road, Draycott, Derby, DE72 3PT.

Sales Tel: 01332 875544      Fax: 01332 874455







## Product Overview

The Parry GB6/GB6P natural gas/LPG 6 burner ovens are robust yet refined. With great versatility the units are ideally suited for a range of catering environments. Excelling in aesthetic appeal, functionality and performance, both units feature six powerful burners and a double-door gas oven. They come with duplex chassis for added rigidity and heavy duty cast-iron pan supports. The units are easy to clean with vitreous enamel lining, provided with castors fitted as standard, two of which are braked.

Features	GB6	GB6P
Unpacked weight (kg)	150	150
Packed weight (kg)	170	170
Dimensions (w x d x h) mm	900 x 790 x 970	900 x 790 x 970
Warranty	2 years	2 years
KW -- Natural	40.1	n/a
KW – Propane	n/a	34.2
Input Gas Connection	3/4" BSP Male	3/4" BSP Male
Gas Input Pressure – natural	20mbar	n/a
Gas Input Pressure – Propane	n/a	37mbar
Can be converted using conversion kit	Yes	Yes

The units lead the industry in:

-  Design and aesthetic appeal
-  Performance
-  Power
-  Functionality
-  After sales support





## Safety Instructions

---

**THIS APPLIANCE IS ONLY FOR PROFESSIONAL USE AND MUST ONLY BE USED BY QUALIFIED PEOPLE.**

Attention should be drawn to the fact that parts of this unit by necessity, will get VERY HOT, and will cause burns if touched accidentally. Therefore, it is the responsibility of the supervisor or equivalent to provide SUITABLE PROTECTIVE CLOTHING for the user.

**THIS APPLIANCE MUST BE FITTED AND TESTED BY A REGISTERED FITTER BEFORE USE.**

The unit should be installed in compliance with the INSTALLATION INSTRUCTIONS and the NATIONAL REGULATIONS in force at the time. Particular attention should be paid to the Gas Safety (Installation and Use) Regulations and the Health and Safety at Work Act.

All commercial gas catering equipment is recommended to be mounted below an extraction canopy. Please consult a ventilation engineer or refer to Guidelines DW172 to calculate the ventilation requirements for cooking areas containing different pieces of gas catering equipment.

Each appliance requires a flow of fresh air for combustion. Under no circumstances should air vents on the appliances, or air vents installed by the fitter in the room of the appliance to supply combustion air, be altered or omitted in any way.

To prevent shocks, all appliances whether gas or electric, must be earthed.

**ANY GAS CONVERSIONS NEEDED TO BE MADE TO THE PRODUCT MUST BE CARRIED OUT BY A GAS SAFE REGISTERED ENGINEER**

To avoid scratching the highly polished exterior surface of this equipment whilst in transit, the protective film on the exterior surfaces has NOT been removed.

It is IMPORTANT that this protective film is peeled off before the equipment is used.



## Installation Instructions

---

Before installation check data plate on rear of unit to ensure appliance is suitable for gas supply available.

During installation provision must be provided for combustion air to the appliance through base and rear of appliance. This should not be blocked at any time. This appliance should be installed with adequate ventilation to prevent the occurrence of unacceptable concentrations of substances harmful to health in the room in which it is installed.

### **POSITIONING**

The appliance must not be installed on or against combustible surfaces – minimum clearances must be:

**Rear 150mm (6")**  
**Sides 150mm (6")**  
**Hotplate to combustible material 1525mm (60")**

All local fire regulations should be observed.

It is recommended that the appliance be sited below a ventilating hood preferably of the extractor type incorporating a grease filter.

The cooker is manufactured with four castors two of which are braked. Caution should be taken when manipulating or moving the unit. The appliance should be attached to a wall with a chain to restrict the movement of the unit once connected to the gas supply. When the unit is installed in position the brakes should be on.

Ensure the appliance is level, by placing a spirit level on the shelf in the oven, not on the pan supports. All four castors are adjustable. To alter the height of the unit, loosen the locking grub screw with an M3 allen key.

Next turn the large nut on the wheel assembly to either raise or lower the unit. When you are happy with the height, tighten the locking grub screw with the M3 allen key.

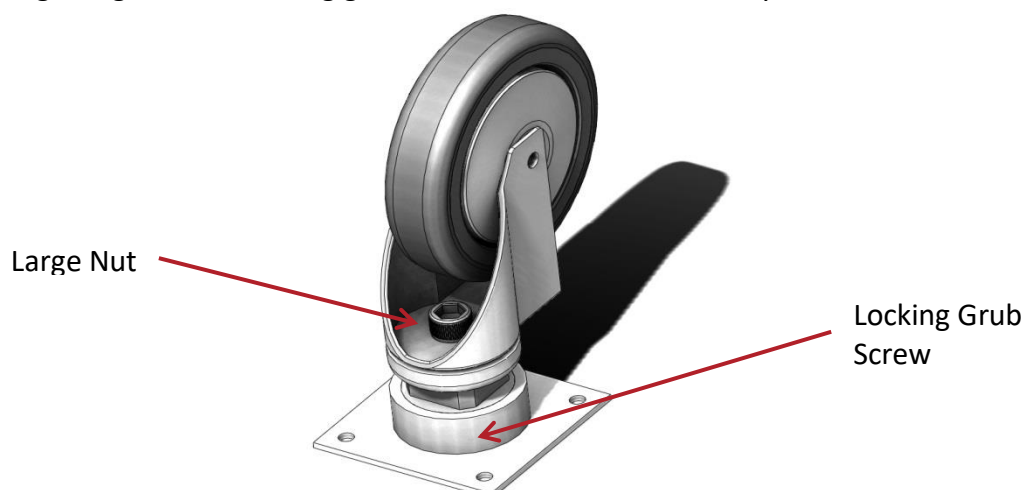



## Installation Instructions

---

The oven doors are held shut by adjustable roller catches. When installing the appliance ensure the catches are set to allow the door to close firmly. To adjust the catch, use a screwdriver to press in roller to below the plate, turn clockwise to adjust downward, and anti-clockwise to lift the roller.

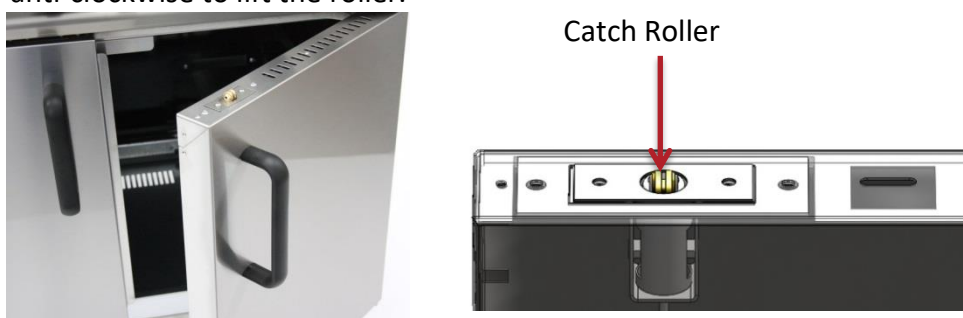

### **GAS CONNECTION**

The size of the supply pipe should be no less than 3/4" B.S.P. and an easily accessible isolation tap fitted close to the appliance in the gas line. Although a rigid connection is recommended. An approved armoured flexible pipe may be used in conjunction with a straining cable.

Before the appliance is commissioned the gas, safety regulations require that all connections on the gas line are tested for gas soundness between the gas meter and the appliance.

All packing and protective film must be removed from panels etc. prior to commissioning the appliance. All gas appliances must be fitted by a competent person to gas safety regulations in force.

Gas hoses used to connect the appliance to the gas supply must be of the correct specification for the gas and pressure of the appliance. The gas hose must comply with the national requirements in force, and be CE marked, of a metal braided construction suitable for commercial catering equipment. The hoses should be periodically examined and replaced as necessary

The tube or hose shall be fitted such that there are no sharp bends or torsional strain which may cause damage or failure of the tube or hose, especially near the end fittings. Torsional strain can be prevented by the use of internal unions, swivel joints, etc. The bend radius should not exceed that stated by the Manufacturer. The hose should not touch the ground and should be no longer than 1.5m long.

A manual valve should be positioned upstream of the tube or hose unless the connection fitting incorporates a self-sealing quick release coupling.



## Installation Instructions

---

Where a quick release coupling is used for horizontal travel such as in commercial catering appliances it is advisable that the coupling is facing downwards to prevent the ingress of debris and ensure the hose is formed in to a smooth curve.

All units should have a restraining cable fitted preventing the unit from being pulled away from the wall and causing the gas hose to become disconnected accidentally.





## Operating Instructions

---

### Operating the hob

All burners are fitted with flame failure devices.

1. To light hob unit turn knob to 
2. Press in and ignite gas with a match, keep knob held in for 15-20 seconds.
3. Release knob, gas should stay lit, if gas goes out repeat stage 2
4. The burner is now on full gas, to turn gas down, turn knob anti-clockwise, this is the  lowest setting, which is factory set.
5. To turn burners off, turn knob clockwise all the way round.

Parry recommends that the hob is used only with pans that have a minimum diameter of 120mm, and up to a maximum of 295mm diameter. This ensures that there is satisfactory combustion, and the pan is stable as it sits on the finger of the pan support.

### Operating the oven

1. To light oven, open doors, turn oven knob to approximate gas mark 5 and hold tap knob in, at the same time press the piezo ignitor button on bottom of the oven.
2. After pressing button 2-3 times burner should light.
3. Keep oven knob depressed for 15-20 seconds.
4. Release knob and flame should remain lit, if not repeat above sequence.
5. If burner goes out refer to fault finding chart.
6. When burner stays on oven is ready for use, select gas mark required, turn knob to setting, oven flame will decrease when desired temperature is reached.





## Operating Instructions

Please take care when opening and closing the doors of an oven that has been turned on. Surfaces and handles will get hot. The surfaces within the oven chamber will be very hot so it is advisable to wear oven gloves to protect from burns that may be incurred from touching hot surfaces within the oven.

We advise these appliances should not be left unattended while switched on. These appliances are for professional use by qualified people only. There are no user serviceable parts.

It is recommended that the sealed top plate is cleaned regularly to prevent build-up of fat and grease.

There are three shelf positions in the oven, the following guide is only intended as a guide to temperature in the centre of the oven. It is strongly recommended that the user makes note of best results, temperatures can vary as much as 20°C hotter at top of oven and 30°C cooler at the bottom of the oven.

These temperatures are measured in an empty oven.

MARK	1	2	3	4	5	6	7	8	9
°C	140	150	165	180	200	220	235	245	260
°F	275	300	328	350	392	425	440	465	500

**Cooking Chart** – the following chart is for guidance only.





USAGE	PRODUCT	GAS TEMP
HIGH TEMP. ROASTING	MEAT OR POULTRY	6 OR 7
LOW TEMP. ROASTING	MEAT OR POULTRY	3
HIGH TEMP. BAKING	BREAD OR SCONES	8
LOW TEMP. BAKING	SLAB CAKE	2
PUDDINGS	MILK PUDDING BAKED CUSTARD }	3
PASTRY	SHORT CRUST PLATE TARTS FLAKY }	7



## Cleaning Instructions

---

The appliance should be cleaned after every use.

-  Allow unit to cool down before cleaning
-  Wipe down the unit using hot soapy ware and a soft cloth, do not use abrasive materials.
-  The wire shelves and the vitreous enamel bottom tray can be removed for cleaning, but the lower tray must be in position when the appliance is in use.
-  Stainless steel cleaners maybe used and cleaning instructions on the product must be adhered to.
-  Never clean the unit with water jets.



## Maintenance Instructions

---

Ensure the appliance is isolated from the power supply before installing, cleaning or maintaining the appliance.

Maintenance and service must only be undertaken by a qualified electrician.



Parry Catering provides a complete after-sales service by offering the sales of spare parts directly to customers. Buying spares straight from the manufacturer allows customer to experience exceptional value and speedy delivery on all spare parts.

For more information on buying spares visit:

[www.parry.co.uk/parry-commercial-catering-spares](http://www.parry.co.uk/parry-commercial-catering-spares)



## Fault Finding

Fault	Check	Solution
<b>HOB</b>		
Incorrect flame picture, flame lift or noisy burner	Incorrect burner pressure, Blocked or partially blocked injector. Inadequate ventilation. Burner faulty/corroded/blocked	Check/adjust burner pressure Check /clean injector, Check ventilation. Check / clean burner and replace as necessary.
Burners will not stay alight	Faulty connection at thermocouple-valve, incorrectly located	Remake connection, reposition thermocouple
Burner goes out when turned to "low"	Blockage in tap	Clean and re-grease
Irregular flame	Burner ring/cap not correctly located, or low pressure	Relocate and check pressure at test point.
<b>OVEN</b>		
Failure to ignite	Dirt or grease broken or loose connection	Clean reconnect / replace H.T. Lead
	Incorrect spark gap	Set gap 3-4mm
Burner fails on low rate	Loose Thermocouple	Replace
	Faulty Magnet in F.F.D.	Replace thermostat
Burner fails on low rate	Thermocouple out of position.	Reposition



## Replacement Parts

---

### For Gas Safe Engineers only

**HOB TAP**- Remove pan supports, pull off control knobs and unclip fascia panel. Disconnect burner supply tube and thermocouple. Undo the 2 screws securing the tap to the rail. Check sealing washer and replace if necessary. Assemble in reverse order.

**HOB BURNER/THERMOCOUPLE** – Remove Pan Supports and Burner caps. Remove the solid top tray.

Disconnect thermocouple from rear of tap. Undo locknut on burner mounting channel. Assemble in reverse order.

**OVEN THERMOSTAT** - Proceed as for hob tap. Slide thermostat phial from housing inside oven. Remove through hole in the top of the oven on right hand side. Assemble in reverse order.

**OVEN THERMOCOUPLE** - Remove the bottom oven tray. Inside the oven disconnect the thermocouple from the extension piece. Undo locknut holding thermocouple to oven burner. Assemble in reverse order. Ensure locknut is securely tightened.

**OVEN BURNER/IGNITON** - Remove oven base. Disconnect oven supply tube, H.T. lead and thermocouple. Burner is held in by 2 screws. Piezo spark generator is secured by a locknut. Electrode secured to burner bracket by centre screw.



## Natural Gas – Conversion Instructions

---

**Product**      **GB6 – 6 Burner Oven LPG**

**For use with models with the following serial numbers**

Model	From	To
GB6P		

**These instructions can be used for converting from LPG to Natural Gas**

LPG units are designed and tested in accordance with all current regulations enforced to run on the following gases only

**PLEASE NOTE**

This conversion must be carried out by a Gas Safe Registered Engineer.

**This conversion kit includes**

	Description	Product Code	Quantity
<b>Hob valve bypass screw</b>	NAT GAS Hob valve bypass screw stamped with 85	COPBPS - 85	6
<b>Hob burner injector</b>	NAT GAS Hob Burner Injector stamped with 185	HOBINJECT185	6
<b>Oven valve bypass screw</b>	NAT GAS Oven valve bypass screw stamped with 70	COPBPS - 70	1
<b>Oven burner injector</b>	NAT GAS oven burner injector stamped with 220	INJECT220	1
<b>Labels</b>		NAT. GAS ONLY	1
<b>Instructions</b>		CONVIN44-1	1



## LPG – Conversion Instructions

---

**Product**      **GB6P – 6 Burner Oven**

**For use with models with the following serial numbers**

Model	From	To
GB6		

**These instructions can be used for converting from Natural Gas to LPG**

LPG units are designed and tested in accordance with all current regulations enforced to run on the following gases only

Propane G31 @ 37mbar 14.8" W.G.

**PLEASE NOTE**

This conversion must be carried out by a Gas Safe Registered Engineer.

**This conversion kit includes**

	Description	Product Code	Quantity
<b>Hob valve bypass screw</b>	LPG hob valve bypass screw stamped 50	COPBPS-50	6
<b>Hob burner injector</b>	LPG hob burner injector stamped 105	HOBINJECT105	6
	LPG oven valve bypass screw stamped 50	COPBPS-50	1
	LPG oven burner injector stamped 150	INJECT150	1
<b>Labels</b>		G31 ONLY,	1
<b>Instructions</b>		CONVIN43-1	1



## Conversion Procedure

### Conversion Procedure for GB6

#### Warning

Ensure the appliance is isolated from the gas supply before commencing conversion

Remove pan support and burner caps / aluminium discs.

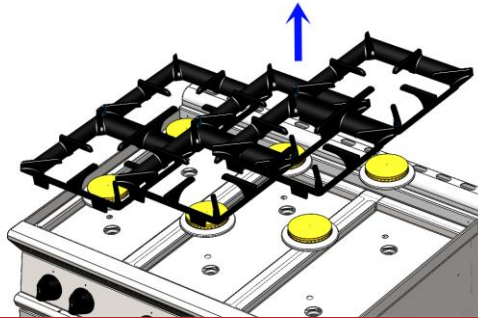

Remove the solid top plates.

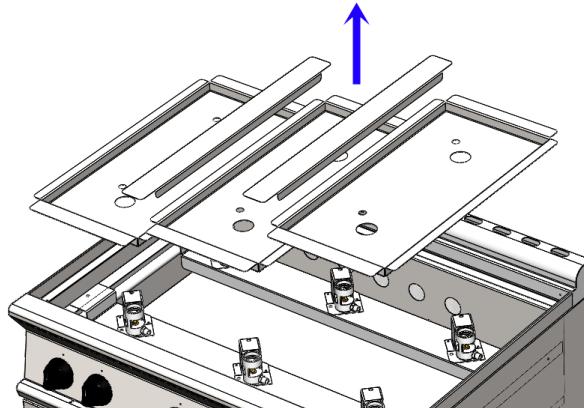

Using a 10mm spanner or nut runner remove burner injector. Replace with injector from conversion kit.  
Replace solid top plates, aluminium burner plates and burner caps.

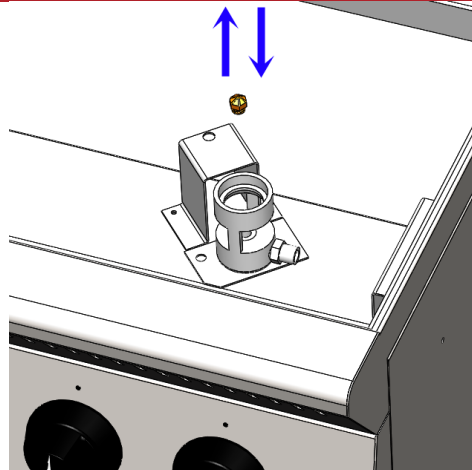





## Conversion Procedure

Remove the tap knobs to allow the fascia to be removed.

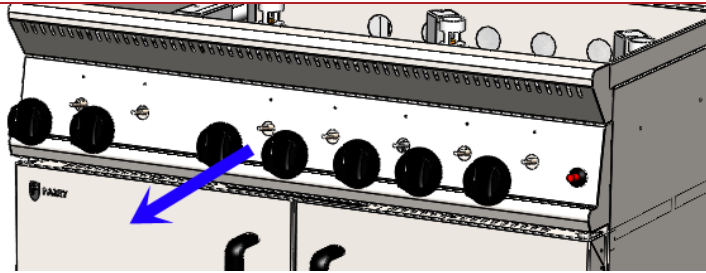

Open doors and underneath the fascia unscrew the 2 x securing screws. Pull fascia away from the bottom. Disconnect HT lead from piezo.

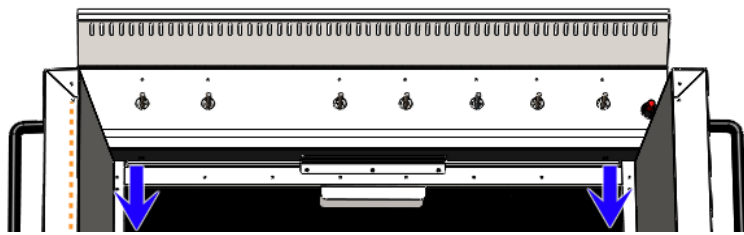

Remove low rate screws in hob tap bodies and replace with low rate screw from the conversion kit.

Replace low rate screw in oven thermostat body from the conversion kit.

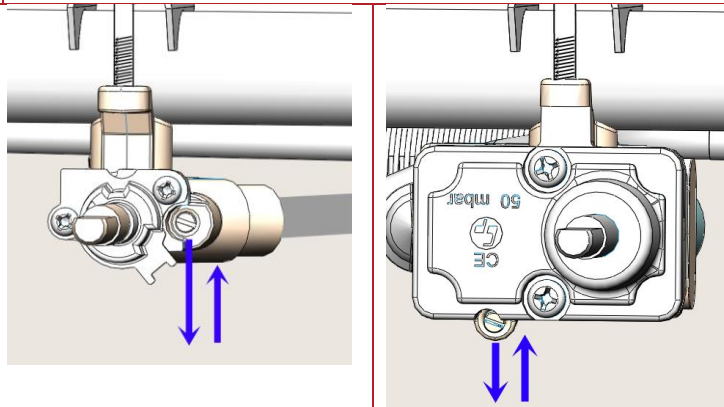

Converting the oven burner.

Remove shelves and bottom tray.

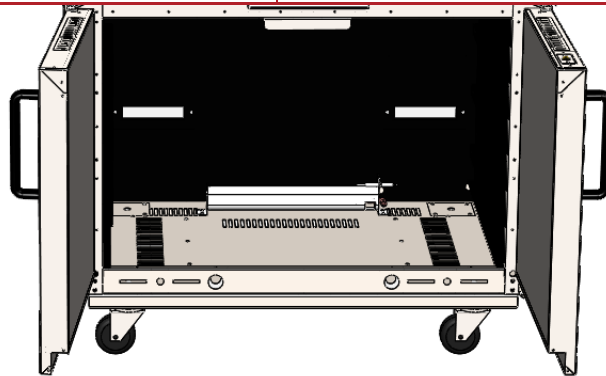

Unscrew the 15mm nut on the jet that goes into the burner.

Unwind anti-clockwise the jet out of the burner.

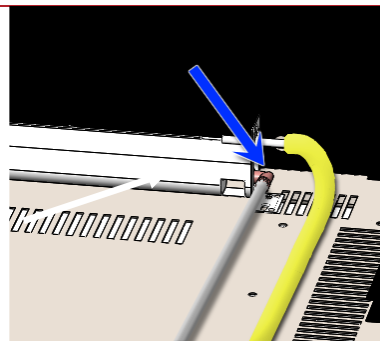



## Conversion Procedure

---

Replace jet with the jet for the required gas.

Refit gas pipe and tighten up the 15mm nut.

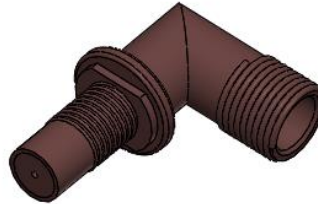

Connect the unit back to the gas supply and test for gas soundness. Replace the fascia and knobs accordingly.



When conversion is complete addix new data label and gas type label supplied with the conversion kit, detailing type of gas and pressure.



## Technical Information

### Per Hob Burner

GAS	OPERATING PRESSURE	TOTAL HEAT INPUT
NATURAL G20	20mb / 8" W.G.	5.557 KW = 18959 Btu/h
PROPANE G31	37mb / 14.8" W.G.	4.351 KW = 14846 Btu/h

GAS RATE	M <sup>3</sup> /HR	FT <sup>3</sup> /HR	LB/HR	KG/HR
NATURAL G20	0.588 M <sup>3</sup> /HR	20.765 FT <sup>3</sup> /HR		
PROPANE G31	0.178 M <sup>3</sup> /HR	6.286 FT <sup>3</sup> /HR	0.691 LB/HR	0.313 KG/HR

BURNER LOW RATE	FLOWRATE	HEAT INPUT
NATURAL G20	0.126 M <sup>3</sup> /HR	1.176 KW
PROPANE G31	0.029 M <sup>3</sup> /HR	0.700 KW

### Per Oven Burner

GAS	OPERATING PRESSURE	TOTAL HEAT INPUT
NATURAL G20	20mb / 8" W.G.	6.804 KW = 23215 Btu/h
PROPANE G31	37mb / 14.8" W.G.	8.140 KW = 27774 Btu/h

GAS RATE	M <sup>3</sup> /HR	FT <sup>3</sup> /HR	LB/HR	KG/HR
NATURAL G20	0.720 M <sup>3</sup> /HR	25.427 FT <sup>3</sup> /HR		
PROPANE G31	0.333 M <sup>3</sup> /HR	11.760 FT <sup>3</sup> /HR	1.292 LB/HR	0.586 KG/HR

### Total Unit

GAS	OPERATING PRESSURE	TOTAL HEAT INPUT
NATURAL G20	20mb / 8" W.G.	40.144 KW = 136970 Btu/h
PROPANE G31	37mb / 14.8" W.G.	34.173 KW = 116599 Btu/h

GAS RATE	M <sup>3</sup> /HR	FT <sup>3</sup> /HR	LB/HR	KG/HR
NATURAL G20	4.248 M <sup>3</sup> /HR	150.017 FT <sup>3</sup> /HR		
PROPANE G31	1.398 M <sup>3</sup> /HR	49.370 FT <sup>3</sup> /HR	5.425 LB/HR	2.460 KG/HR
AIR FLOW RATE FOR COMBUSTION 20m <sup>3</sup> /HR		44.52 FT <sup>3</sup> /HR		

BURNER LOW RATE	FLOWRATE	HEAT INPUT
NATURAL G20	0.758 M <sup>3</sup> /HR	7.070 KW
PROPANE G31	0.175 M <sup>3</sup> /HR	4.200 KW



## Service Information

---

This appliance should be routinely serviced to prolong its lifetime. Parry recommends that the appliance is serviced every 12 months by a Parry authorised engineer. Failure to service your product within the initial 12 month warranty period will cause the 24 month warranty to become void.

If the supply cord becomes damaged, it must be replaced by the manufacturer, it's service agent, or a similarly qualified person.

### Enhanced 2 Years Warranty

Parry Catering (Midlands) Ltd offer an enhanced warranty of two years (including parts and labour) on all of the Parry manufactured products. To take advantage of this you should register your warranty by logging onto the company website and filling out our simple form.

[www.parry.co.uk/the-parry-warranty](http://www.parry.co.uk/the-parry-warranty)

If you have any issues with your product and wish to request a warranty call you can contact our friendly team who will organize a Parry approved service engineer to attend and fix your problem.

All warranty requests can be sent to [warranty@parry.co.uk](mailto:warranty@parry.co.uk) alternatively call our warranty department for technical assistance on **01332 875544**





# Exploded View

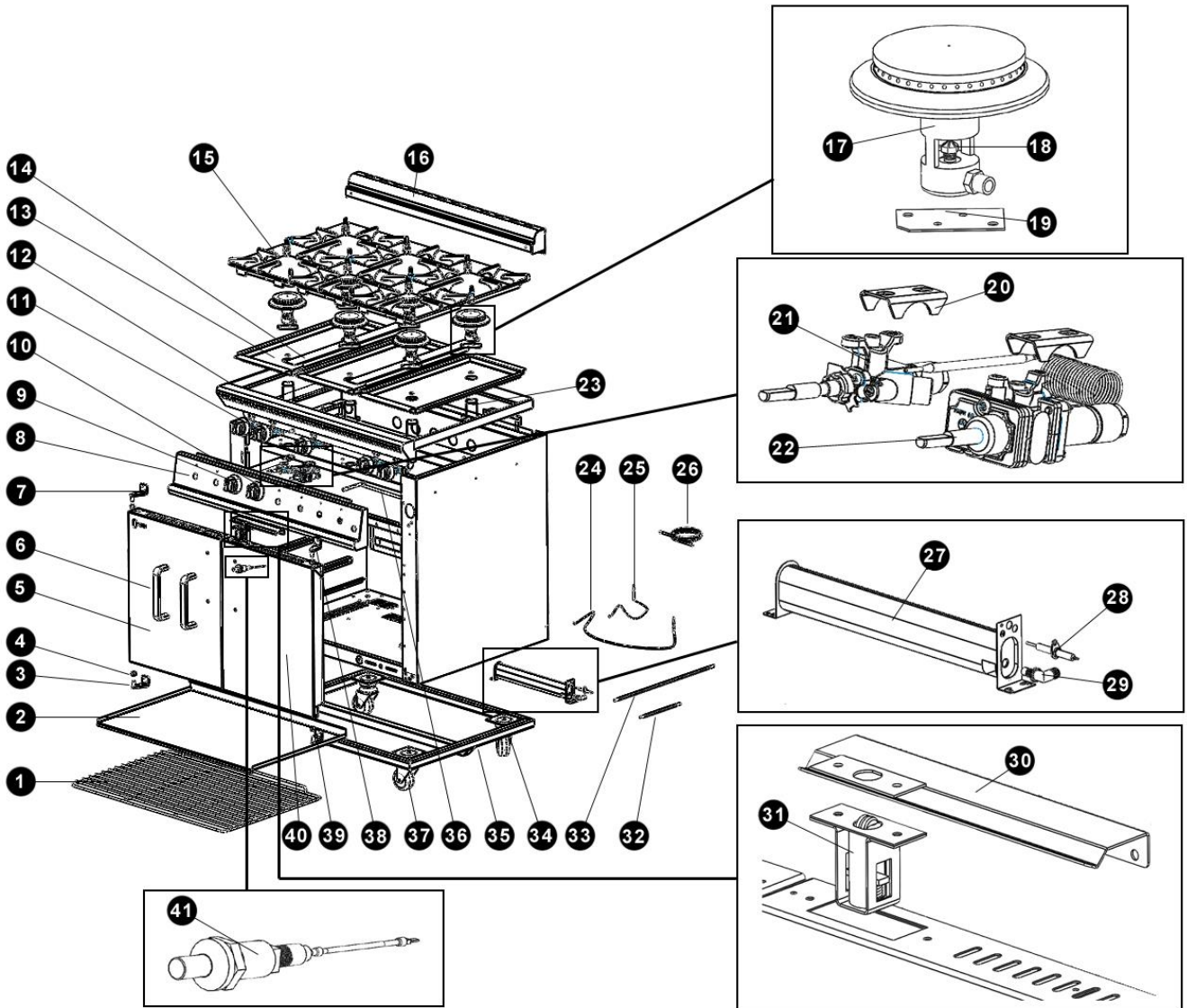



## Parts List

Part Number	Description	Code
1	Shelf	TRWC00750
2	*Tray	*No Code
3	Bottom LH Hinge	ULT6BOHINGEBL
4	Hinge Bush	ULTHINGEBUSH
5	LH Door	
6	Door Handle	GB6HANDLE
7	Top LH Hinge	ULT6BOHINGETL
8	*Fascia	*No Code
9	Control Knob Hob	ULTKNOB5A
10	Control Knob Oven	ULTKNOB4A
11	Gas Rail	GB6GASRAIL
12	*Top Surround	*No Code
13	*Top Cover	*No Code
14	*Middle Cover	*No Code
15	Pan Support	CASTP6BO
16	*Flue Cover	*No Code
17	Hob Burner Complete with Injector Carriage	BURNRHOB
18	Hob Injector (Nat) Hob Injector (LPG)	HOBINJECT185 HOBINJECT105
19	*Injector Carriage Plate	*No Code
20	Saddle Bracket	SADDLEBKT
21	Hob Gas Valve	GASTAPHOB
21a	Hob Bypass Screw (Nat) Hob Bypass Screw (LPG)	COPBPS-70 COPBPS-50
22	Oven Valve	OVENVALVE
22a	Oven Bypass Screw (Nat) Oven Bypass Screw (LPG)	COPBPS-85 COPBPS-50
23	*Thermocouple Bracket	*No Code
24	600mm Thermocouple	THCP600ISP
25	320mm Thermocouple	THCP320ISP



## Parts List

Part Number	Description	Code
25a	Thermocouple Extension Lead	THERMCOUPEXT
26	1830mm HT Lead	CABLHT1830
26a	High Temperature Sleeving (Length mm)	SBSY00GAS
27	Oven Burner	BURNROVEN
28	Electrode	ELECT7013
29	Oven Injector (Nat) Oven Injector (LPG)	INJECT220 INJECT150
30	Door Keep	LCPDOORKEEP
31	Ball Catch Assembly	
32	Flexi Tube 200mm	FLEXT200X8
33	Flexi Tube 500mm	FLEXT500X8
34	75mm Swivel Castor	CASTOR75SW
35	*Chassis	*No Code
35a	Leg Plate	LEGPLATE
36	Oven Gas Pipe	OVENPIPE1
37	75mm Swivel Braked Castor	CASTOR75BR
38	Top RH Hinge	ULT6BOHINGETR
39	Bottom RH Hinge	ULT6BOHINGEBR
40	RH Door	
41	Piezo + Link Lead	GB6PPIEZO
	Adjuster Boss for Castors	ADJM12
	Door Seal	SEALPGS10
	Door Seal Dart Clips ( <b>18 Per unit</b> )	CLIP01180
	Flue Joining Gasket	GASK07013
	Oven Insulation Set	RKWL07013

\*Metalwork Components



## Warranty Information

---

The manufacturer's warranty is only valid in the UK mainland. Northern Ireland, Western Isles, Inner Hebrides and Islands are parts only warranty. Please be aware that the warranty starts from the date of purchase from Parry and not the sale or installation date of the equipment.

To be eligible for a 2 year warranty, products must be serviced at least once within the first 12 months of purchase.

All service calls will be carried out between 8am and 5pm, Monday to Friday.

Your warranty is invalid if your equipment has not been installed in accordance with the manufacturer's instructions. The misuse, alteration or unauthorised repairs of the equipment will also invalidate the warranty.

During the warranty period it is at Parry's discretion whether to repair or replace the equipment.

The warranty only applies if the equipment has been used in a professional manner following the manufacturer's instructions and maintenance guidelines.

The warranty covers defects in the material and component failure only. We are not liable for trading loss, loss of perishable items, water damage or loss due to injury or fire damage.

Please ensure you have referred to the manufacturer's instruction before placing a warranty call.

Contact our warranty department on **01332 875544** for technical assistance.











Please have your model number ready before calling.

All warranty requests must be submitted to [warranty@parry.co.uk](mailto:warranty@parry.co.uk).

Failure to pay any warranty charges will result in your warranty being put on hold until the bill has been settled. Any issues regarding the raised charges should be put in writing to our warranty department for further investigation.

Register your product by visiting our website [www.parry.co.uk](http://www.parry.co.uk)

### Not covered under warranty

-  Fault due to incorrect installation, poor maintenance or equipment abuse.
-  Resetting of equipment or circuit breakers.
-  Faulty electrics – e.g. customer's plug socket, plug, wiring, junction box fault, wrong fuse.
-  Products must be serviced within the first 12 months to be eligible for the 2 year warranty
-  Product not covered by warranty if combustible materials have been used, e.g. plastic trays.
-  Foil used on racks, blockages and lime scale issues.
-  Failure to grant access for pre-arranged service call.
-  Equipment that has been set up or used incorrectly e.g. dishwasher detergents, levelling and setting up of doors on a six burner cooker.
-  Excessive carbon build-up on griddle plates or overuse of lava rock on chargrills. (Recommended use by Parry no more than 2kg.)
-  All of the above points are not covered by warranty and any costs incurred, because of the above, will be forwarded to the parties responsible for placing the call.





## Disposal & Recycling

---

The packaging should be disposed of according to regulations in force.